

# TPD1046F

## 2-IN-1 Low-Side Power Switch for Motor, Solenoid and Lamp Drive

The TPD1046F is a 2-IN-1 low-side switch.

The IC has a vertical MOSFET output which can be directly driven from a CMOS or TTL logic circuit (e.g., an MPU). The IC is equipped with intelligent self-protection functions.

### Features

- Two built-in power IC chips with a structure combining a control block and a vertical power MOSFET (L<sup>2</sup>-π-MOS) on each chip.
- Can directly drive a power load from a CMOS or TTL logic.
- Built-in protection circuits against overvoltage (active clamp), overtemperature (thermal shutdown), and overcurrent (current limiter).
- Low Drain-Source ON-resistance:  $R_{DS(ON)} = 0.2 \Omega$  (max) (@ $V_{IN} = 5 \text{ V}$ ,  $I_D = 1 \text{ A}$ ,  $T_{ch} = 25^\circ\text{C}$ )
- Low Leakage Current:  $I_{DSS} = 10 \mu\text{A}$  (max) (@ $V_{IN} = 0 \text{ V}$ ,  $V_{DS} = 30 \text{ V}$ ,  $T_{ch} = 25^\circ\text{C}$ )
- Low Input Current:  $I_{IN} = 600 \mu\text{A}$  (max) (@ $V_{IN} = 5 \text{ V}$ ,  $T_{ch} = -40\sim 125^\circ\text{C}$ )
- 8-pin SOP package with embossed-tape packing.

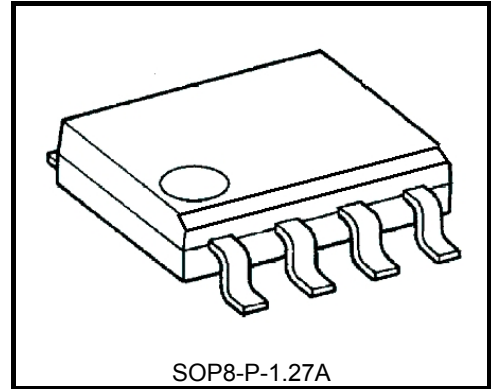

Weight: 0.08 g (typ.)

### Pin Assignment (top view)

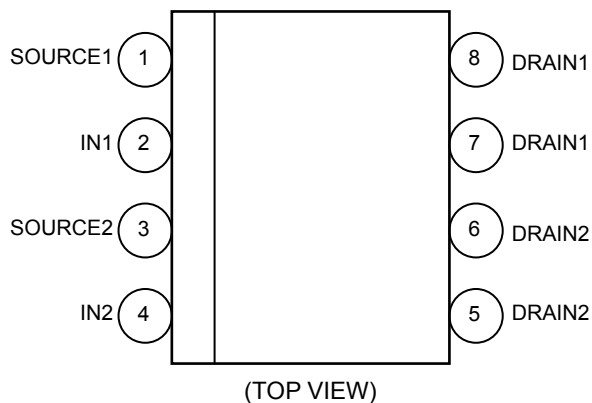

### Marking

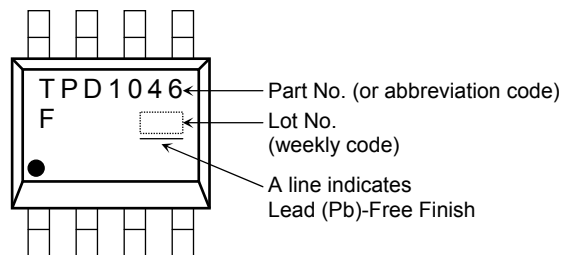

Note 1: Due to its MOS structure, this product is sensitive to static electricity.

**Block Diagram**

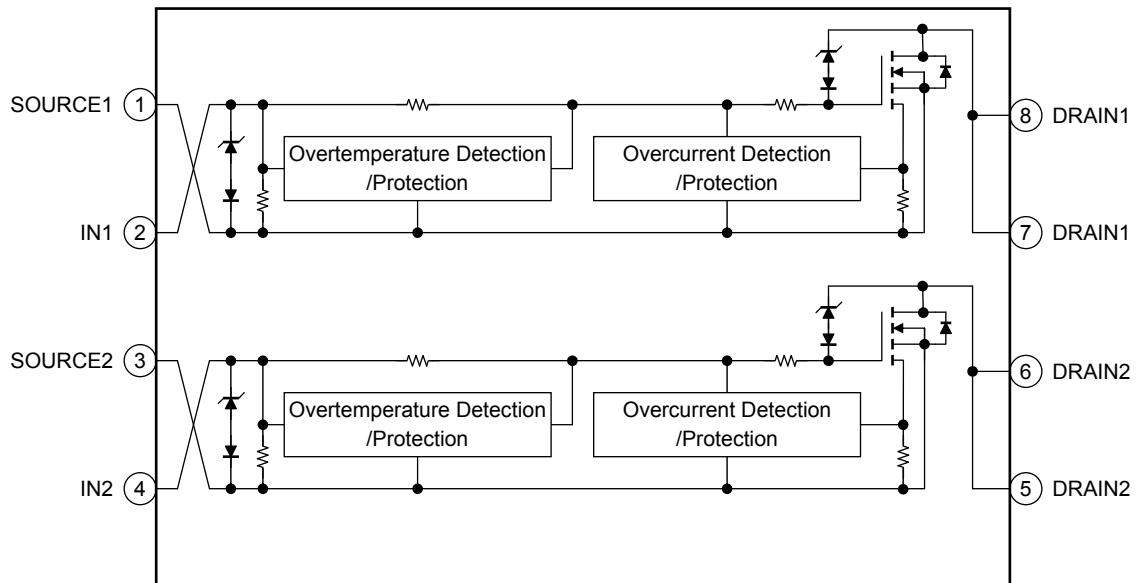

**Pin Description**

Pin No.	Symbol	Pin Description
1	SOURCE1	Source pin 1
2	IN1	Input pin 1 This pin is connected to a pull-down resistor internally, so that even when input wiring is open-circuited, output can never be turned on inadvertently.
3	SOURCE2	Source pin 2
4	IN2	Input pin 2 This pin is connected to a pull-down resistor internally, so that even when input wiring is open-circuited, output can never be turned on inadvertently.
5, 6	DRAIN2	Drain pin 2 Drain current is limited (by current limiter) if it exceeds 3 A (min) in order to protect the IC.
7, 8	DRAIN1	Drain pin 1 Drain current is limited (by current limiter) if it exceeds 3 A (min) in order to protect the IC.

**Timing Chart**

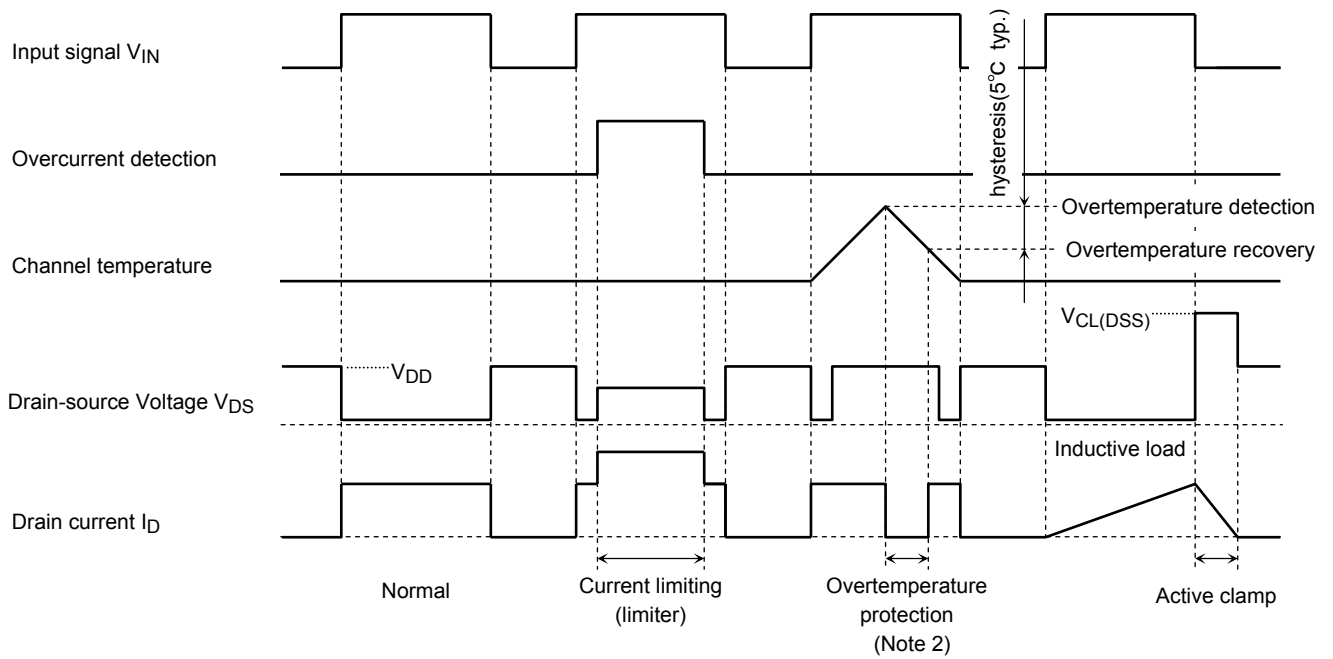

Note 2: The overtemperature detector circuits feature hysteresis. After overtemperature is detected, normal operation is restored only when the channel temperature falls by the hysteresis amount (5°C typ.) in relation to the overtemperature detection temperature.

**Truth Table**

$V_{IN}$	$V_{DS}$	Output State	Operating State
L	H	OFF	Normal
H	L	ON	
L	H	OFF	Overcurrent
H	H	current limiting(limiter)	
L	H	OFF	Overtemperature
H	H	OFF	

## Absolute Maximum Ratings (Ta = 25°C)

Characteristics		Symbol	Rating	Unit
Drain-source voltage		$V_{DS(DC)}$	40	V
Drain current		$I_D$	Internally Limited	A
Input voltage		$V_{IN}$	-0.3~7	V
Power dissipation (Ta = 25°C) (Note 3-a)	1device operation (Note 4a)	$P_{D(1)}$	0.95	W
	2 devices operation per device (Note 4b)	$P_{D(2)}$	0.54	W
Power dissipation (Ta = 25°C) (Note 3-b)	1device operation (Note 4a)	$P_{D(1)}$	0.38	W
	2 devices operation per device (Note 4b)	$P_{D(2)}$	0.20	W
Single pulse active clamp tolerance (Note 5)		$E_{AS}$	97	mJ
Active clamp current		$I_{AR}$	3	A
Repetitive active clamp tolerance (Note 3-a) (Note 6)		$E_{AR}$	54	$\mu J$
Operating temperature		$T_{opr}$	-40~125	°C
Channel temperature		$T_{ch}$	150	°C
Storage temperature		$T_{stg}$	-55~150	°C

## Thermal Characteristics

Characteristics		Symbol	max	Unit
Thermal resistance, channel to ambient (Note 3-a)	1device operation (Note 4a)	$R_{th(ch-a)(1)}$	132	°C/W
	2 devices operation per device (Note 4b)	$R_{th(ch-a)(2)}$	231	
Thermal resistance, channel to ambient (Note 3-b)	1device operation (Note 4a)	$R_{th(ch-a)(1)}$	330	°C/W
	2 devices operation per device (Note 4b)	$R_{th(ch-a)(2)}$	625	

Note: Using continuously under heavy loads (e.g. the application of high temperature/current/voltage and the significant change in temperature, etc.) may cause this product to decrease in the reliability significantly even if the operating conditions (i.e. operating temperature/current/voltage, etc.) are within the absolute maximum ratings and the operating ranges.

Please design the appropriate reliability upon reviewing the Toshiba Semiconductor Reliability Handbook ("Handling Precautions"/Derating Concept and Methods) and individual reliability data (i.e. reliability test report and estimated failure rate, etc).

Note 3:

3-a : glass epoxy board (a)

3-b : glass epoxy board (b)

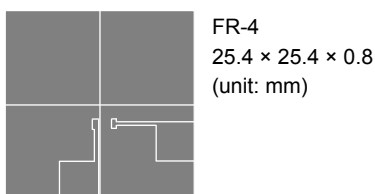

(a)

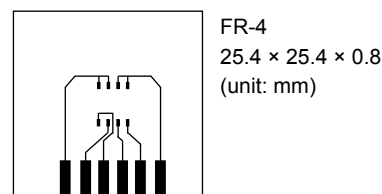

(b)

Note 4:

- a) 1 device operation : power dissipation value or thermal resistance of one side device.
- b) 2 devices operation per device : power dissipation value or thermal resistance per device when power is impressed evenly.

Note 5:  $V_{DD} = 25\text{ V}$ ,  $T_{ch} = 25^{\circ}\text{C}(\text{initial})$ ,  $L = 10.8\text{ mH}$ ,  $I_{AR} = 3\text{ A}$ ,  $R_G = 25\ \Omega$

Note 6: Repetitive rating : Pulse width limited by maximum channel temperature.

## Electrical Characteristics

Characteristics		Symbol	Test Circuit	Test Condition	Min	Typ.	Max	Unit	
Drain-source clamp voltage	$V_{(CL) DSS}$	-	-	$T_{ch} = 25^{\circ}C$	40	49	60	V	
				$T_{ch} = -40 \sim 125^{\circ}C$					$V_{IN} = 0 V,$ $I_D = 1 mA$
Input threshold voltage	$V_{th}$	-	-	$T_{ch} = 25^{\circ}C$	1.0	1.6	2.8	V	
				$T_{ch} = -40 \sim 125^{\circ}C$					$V_{DS} = 13 V,$ $I_D = 10 mA$
Protective circuit operation input voltage range	$V_{IN (opr)}$	-	-	$T_{ch} = -40 \sim 125^{\circ}C$	4	-	7	V	
Drain cut-off current	$I_{DSS}$	-	-	$T_{ch} = 25^{\circ}C$	-	-	10	$\mu A$	
				$T_{ch} = -40 \sim 125^{\circ}C$			$V_{IN} = 0 V,$ $V_{DS} = 12 V$		30
High level input current	$I_{IH (1)}$	-	-	$T_{ch} = 25^{\circ}C$	-	130	600	$\mu A$	
				$T_{ch} = -40 \sim 125^{\circ}C$			$V_{IN} = 5 V,$ at normal operation		600
High level input current	$I_{IH (2)}$	-	-	$T_{ch} = -40 \sim 125^{\circ}C$	-	-	2000	$\mu A$	
				$V_{IN} = 5 V,$ when protective circuit is actuated					
Drain-source on resistance	$R_{DS (ON)}$	-	-	$T_{ch} = 25^{\circ}C$	-	0.14	0.2	$\Omega$	
				$T_{ch} = -40 \sim 125^{\circ}C$			$V_{IN} = 5 V,$ $I_D = 1 A$		0.3
Load-short tolerance	$V_{DS}$	-	-	$T_{ch} = -40 \sim 125^{\circ}C$	20	-	-	V	
Overtemperature detection	temperature detection	$T_{OT(1)}$	-	-	-	-	-	150	$^{\circ}C$
	temperature recovery	$T_{OT(2)}$	-					125	
Overcurrent detection	$I_{OC}$	-	-	$T_{ch} = 25^{\circ}C$	-	3.7	-	A	
				$T_{ch} = -40 \sim 125^{\circ}C$			$V_{IN} = 5 V$		2.0
Switching time	$t_{on}$	1	-	$T_{ch} = 25^{\circ}C$	-	15	100	$\mu s$	
				$T_{ch} = -40 \sim 125^{\circ}C$			$V_{DD} = 13 V,$ $V_{IN} = 0 V/5 V,$ $R_L = 13 \Omega$		100
	$T_{ch} = 25^{\circ}C$			30			100		
	$T_{ch} = -40 \sim 125^{\circ}C$			-			-		100
Drain-source diode forward voltage	$V_{DSF}$	-	-	$T_{ch} = 25^{\circ}C$	-	-	1.7	V	

### Test Circuit 1

#### Switching time measuring circuit

Test circuit

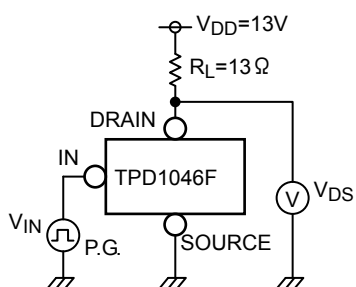

Measured waveforms

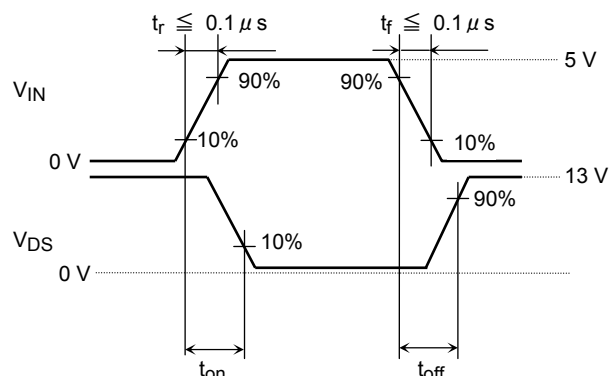

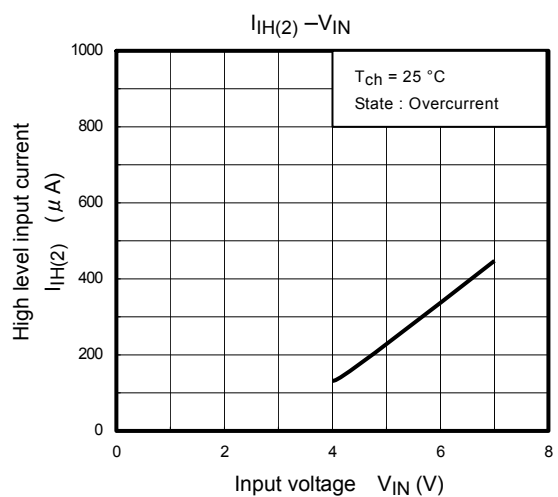
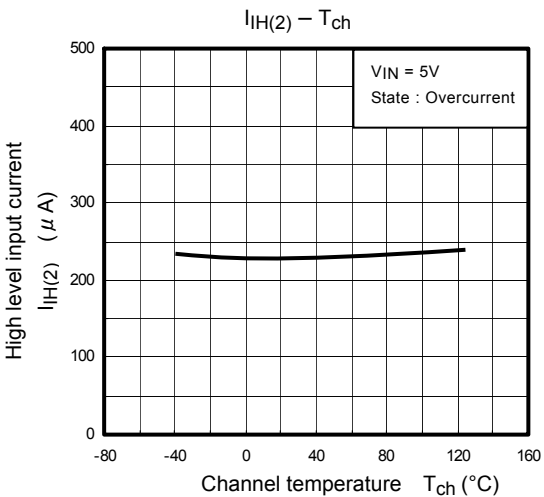
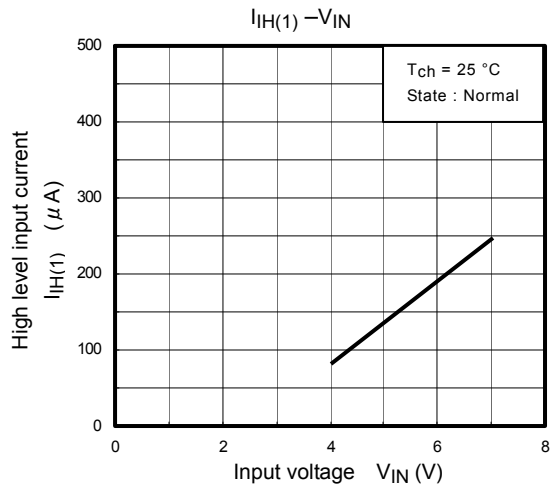
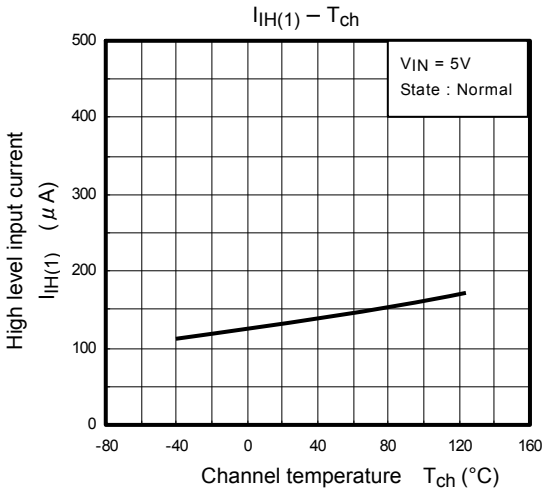
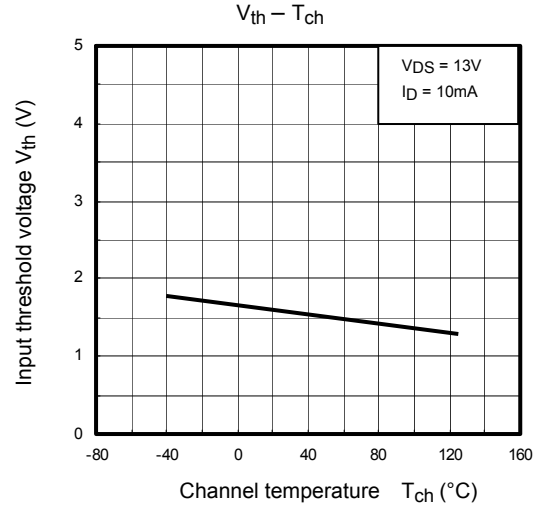
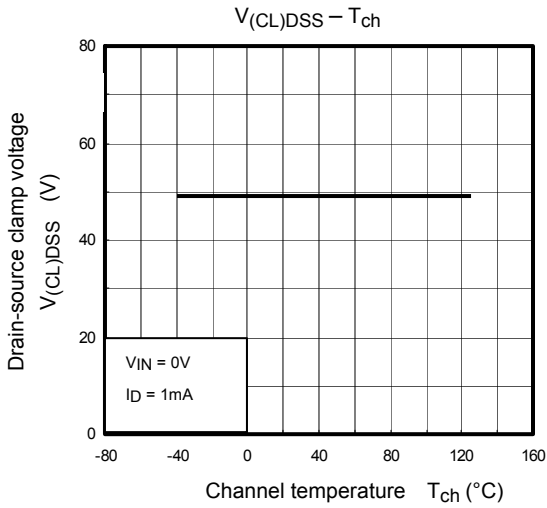

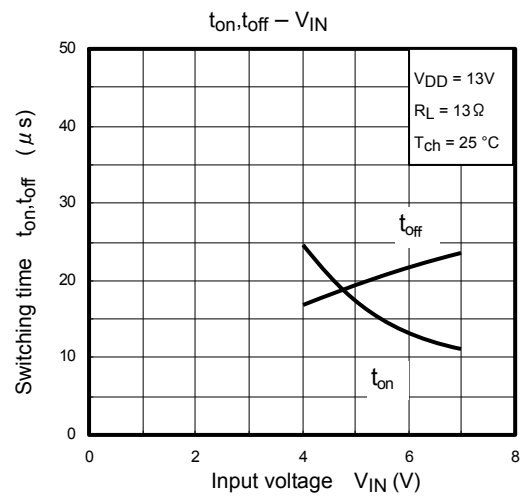
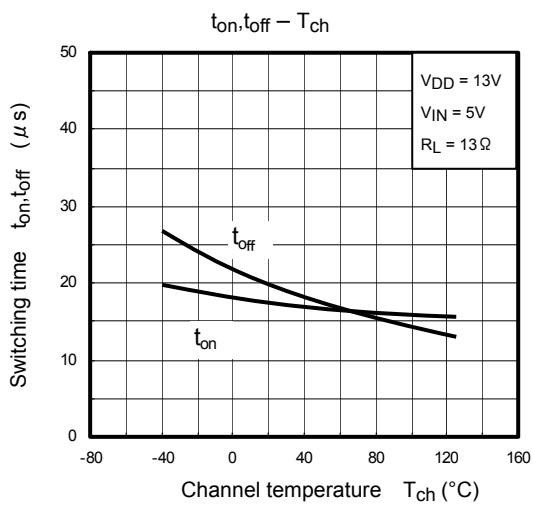
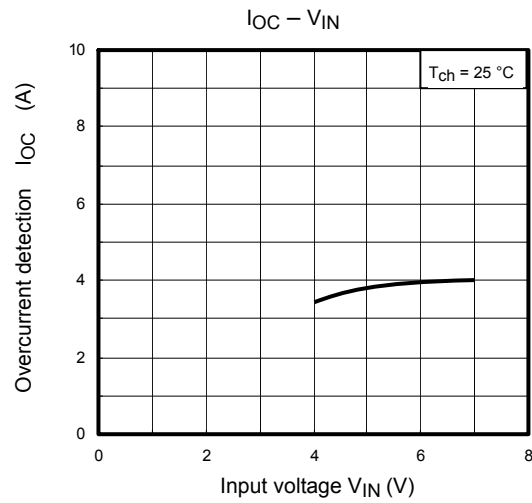
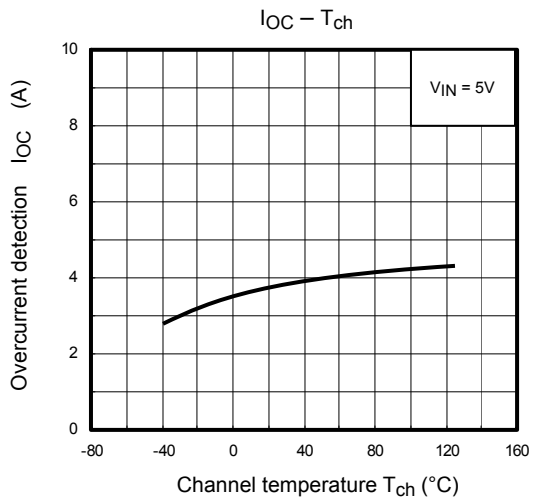
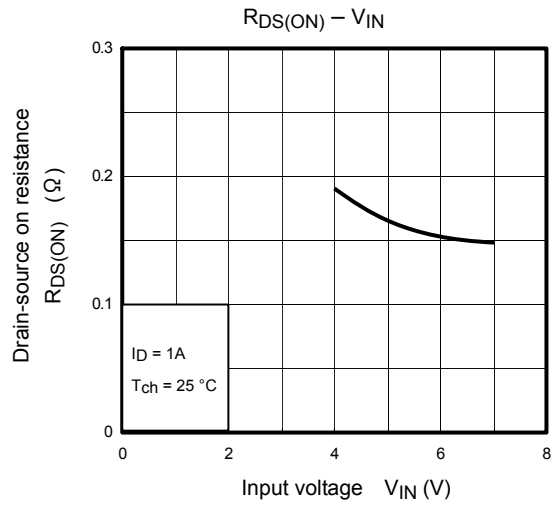
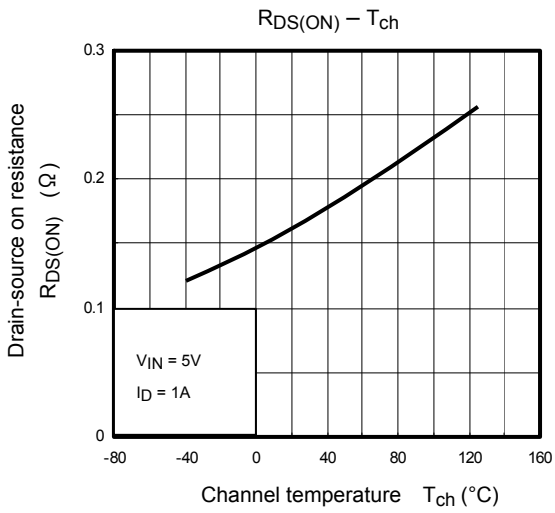



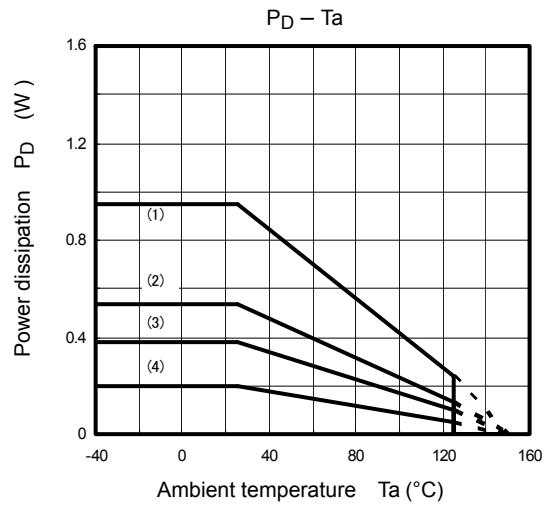
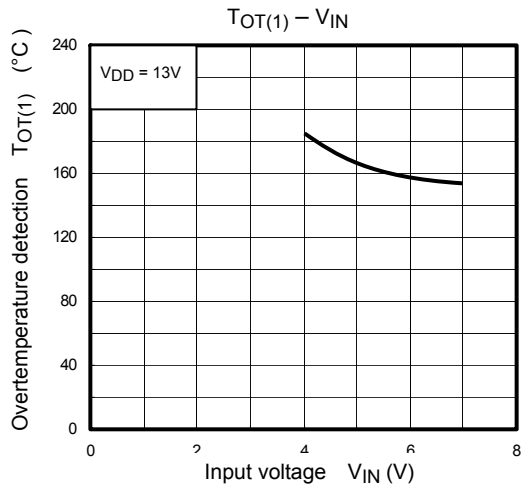

- (1) Mounted on glass epoxy board(a) 1 device operation
- (2) Mounted on glass epoxy board(a) 2 devices operation (per device)
- (3) Mounted on glass epoxy board(b) 1 device operation
- (4) Mounted on glass epoxy board(b) 2 devices operation (per device)

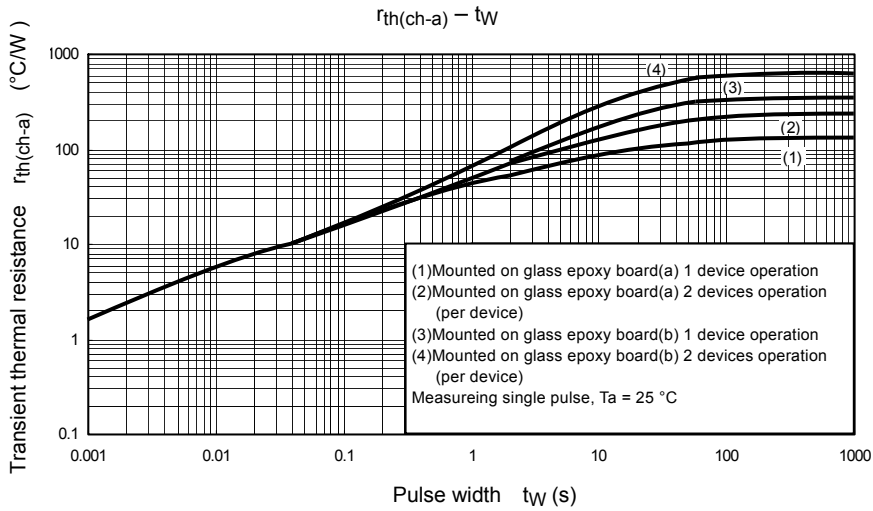

Package Dimensions

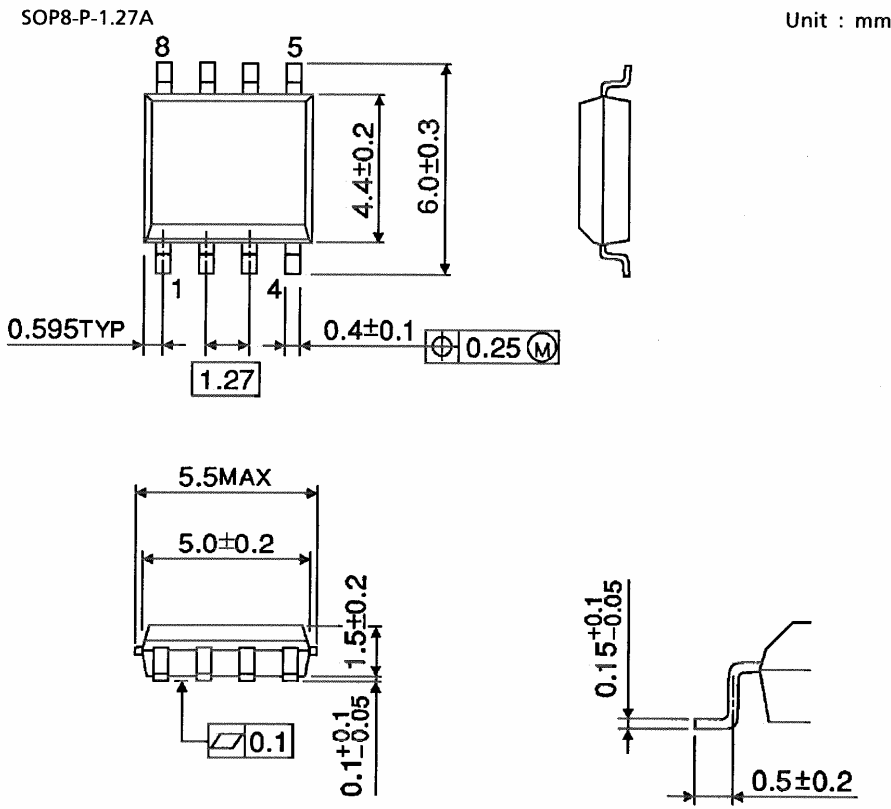

Weight: 0.08 g (typ.)

**RESTRICTIONS ON PRODUCT USE**

20070701-EN GENERAL

- The information contained herein is subject to change without notice.
- TOSHIBA is continually working to improve the quality and reliability of its products. Nevertheless, semiconductor devices in general can malfunction or fail due to their inherent electrical sensitivity and vulnerability to physical stress. It is the responsibility of the buyer, when utilizing TOSHIBA products, to comply with the standards of safety in making a safe design for the entire system, and to avoid situations in which a malfunction or failure of such TOSHIBA products could cause loss of human life, bodily injury or damage to property.  
In developing your designs, please ensure that TOSHIBA products are used within specified operating ranges as set forth in the most recent TOSHIBA products specifications. Also, please keep in mind the precautions and conditions set forth in the "Handling Guide for Semiconductor Devices," or "TOSHIBA Semiconductor Reliability Handbook" etc.
- The TOSHIBA products listed in this document are intended for usage in general electronics applications (computer, personal equipment, office equipment, measuring equipment, industrial robotics, domestic appliances, etc.). These TOSHIBA products are neither intended nor warranted for usage in equipment that requires extraordinarily high quality and/or reliability or a malfunction or failure of which may cause loss of human life or bodily injury ("Unintended Usage"). Unintended Usage include atomic energy control instruments, airplane or spaceship instruments, transportation instruments, traffic signal instruments, combustion control instruments, medical instruments, all types of safety devices, etc.. Unintended Usage of TOSHIBA products listed in this document shall be made at the customer's own risk.
- The products described in this document shall not be used or embedded to any downstream products of which manufacture, use and/or sale are prohibited under any applicable laws and regulations.
- The information contained herein is presented only as a guide for the applications of our products. No responsibility is assumed by TOSHIBA for any infringements of patents or other rights of the third parties which may result from its use. No license is granted by implication or otherwise under any patents or other rights of TOSHIBA or the third parties.
- Please contact your sales representative for product-by-product details in this document regarding RoHS compatibility. Please use these products in this document in compliance with all applicable laws and regulations that regulate the inclusion or use of controlled substances. Toshiba assumes no liability for damage or losses occurring as a result of noncompliance with applicable laws and regulations.